

Carta dei Vini

Wine List



AGRITURISMO LA MARGHERITA

LEGENDA

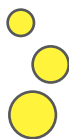

Spumanti
Sparkling Wines



Spumanti Rosé
Rosé Sparkling Wines



Vini Bianchi
White Wines



Vini Rosati
Rosé Wines



Vini Rossi
Red Wines

Vini Biologici Certificati
Biological Wines

Viticultura ecosostenibile
Eco-sustainable viticulture



INDICE

01

Spumanti Italiani

Italian Sparkling Wines

04

Spumanti Francesi

French Sparkling Wines

06

Vini Bianchi e Rosati Piemontesi

Piedmont White and Rosé Wines

10

Vini Bianchi e Rosati Italiani

Italian White and Rosé Wines

13

Vini Rossi Piemontesi

Piedmont Red Wines

28

Vini Rossi italiani

Italian Red Wines

31

Vini Dolci

Sweet Wines

Spumanti Italiani





























Italian Sparkling Wines



AGRITURISMO LA MARGHERITA

01

PIEMONTE

   Contratto - Met. Cl. Millesimato <i>80 Pinot Nero, 20 Chardonnay - Pas dosè</i> Comuni dell'Alta Langa	2016	32€	Sb: 17-12-21	12.50%
   Contratto - Alta Langa For England Rosé <i>100 Pinot Nero - Pas dosè</i> Comuni dell'Alta Langa	2016	48€	Sb: 01-21	12.50%
   Daffara & Grasso - Altalanga <i>70 Pinot Nero, 30 Chardonnay - Brut</i> Calosso	2017	30€	Sb: 05-21	12.50%
   Deltetto - Met. Cl. Rosé de Nour "N" <i>Nebbiolo e Pinot Nero - Brut</i> Canale	2016	33€	Sb: 09-21	12.50%
   Marcalberto Altalanga <i>Pinot Nero, Chardonnay - ExtraBrut</i> Santo Stefano Belbo	2017	40€	Sb: 2021	12.50%
   Marcalberto Met. Classico Nature <i>Pinot Nero - Nature - Senza Solfiti Aggiunti</i> Santo Stefano Belbo	s.a.	50€	Sb: 2020	12.00%
   Serafino - Alta Langa Oudeis Rosé de Saignée <i>100 Pinot Nero - Brut</i> Canale	2017	35€		12.50%
   Serafino - Alta Langa Zero Riserva s.t. <i>100 Pinot Nero - Pas dosé</i> Canale	2015	50€		12.50%
   Serafino - Alta Langa Zero Riserva s.t. <i>100 Pinot Nero - Pas dosé</i> Canale	2014	50€		12.50%
   Serafino - Alta Langa Parcellaire <i>95 Pinot Nero - 5 Chardonnay - Extra Brut</i> Canale	2017	40€		12.50%

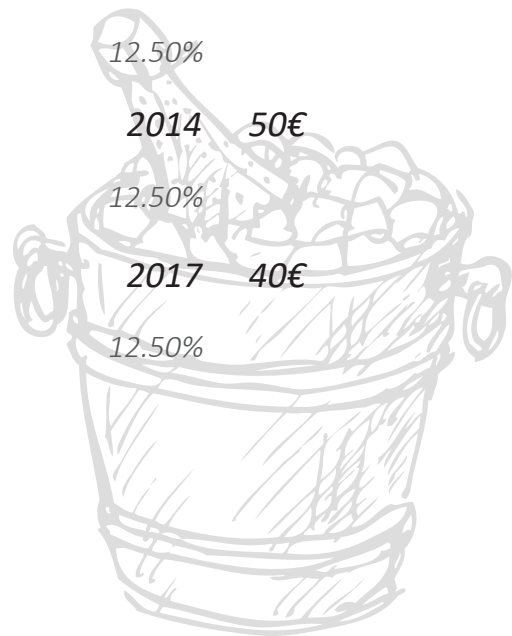

LOMBARDIA

- ● **Ca' del Bosco - Franciacorta Ris. Anna Maria Clementi** 2010 180€
● 55 Chardonnay, 25 Pinot Bianco, 20 Pinot Nero - Dosage Zéro
Erbusco (BS) Sb: 07-19 12.50%
- ● **Camilucci - Franciacorta Ammonites** s.a. 33€
● 75 Chardonnay, w5 Pinot Bianco, 20 Pinot Nero - Brut
Paderno Franciacorta (BS) Sb: 10-21 12.00%
- ● **Camilucci - Franciacorta Riserva S.T.** 2011 50€
● 100 Chardonnay - Brut Nature
Paderno Franciacorta (BS) Sb: 03-21 12.50%
- ● **Faccoli - Franciacorta Dosaggio Zero** 2016 50€
● Chardonnay, Pinot Nero, Pinot Bianco
Coccaglio (BS) Sb: 02-09-21 12.50%
- ● **Faccoli - Franciacorta Rosé** s.a. 40€
● Chardonnay, Pinot Nero, Pinot Bianco
Coccaglio (BS) Sb: 02-09-21 12.50%

BASILICATA

- ● **Terra dei Re - Met. Cl. Vulcano 800 Rosé** 2018 30€
● 100 Pinot Nero - Brut
Rionero in Vulture (PZ) Sb: 2021 12.50%



EMILIA ROMAGNA

 **Cleto Chiarli - Rosé de Noir** s.a. 18€
100 Grasperossa - Brut
Modena 12.00%

VENETO

 **Il Roccolo di Monticelli - Cinciallegra** s.a. 22€
Vignaioli artigiani, biologico senza solforosa aggiunta
Cognola al colle (VR) 10.50%

 **Le Colture - Prosecco di Valdobbiadene Pianer** s.a. 18€
100 Glera - Extra Dry
Valdobbiadene 11.00%



Spumanti Francesi

French Sparkling Wines



CHAMPAGNE

Bollinger - Special Cuvée	s.a.	95€
60 Pinot Nero, 25 Chardonnay, 15 Pinot Munier - Brut		
Vallée de la Marne - Aÿ	12.00%	
Bollinger - B13	2013	170€
100 Pinot Nero - Extra Brut		
Vallée de la Marne - Aÿ	12.50%	
Bonnet-Ponson - Cuvée perpétuelle Premier Cru	s.a.	60€
40 Pinot Nero, 30 Chardonnay, 30 Pinot Munier - Extra Brut		
Montagne de Reims - Chamery	Sb: 11-21	12.50%
Jacquesson - Cuvée 744	s.a.	100€
35 Pinot Nero, 45 Chardonnay, 20 Pinot Munier - Extra Brut		
Vallée de la Marne - Dizy	Sb: 01-21	12.50%
Leseurre Gilbert - Tradition	s.a.	50€
100 Pinot Noir - Brut		
Aube - Arrentières	Sb: 09-20	12.00%
André Heucq - Heritage Blanc de Munier	s.a.	68€
100 Pinot Meunier - Nature		
Vallée de la Marne - Cuisles	Sb: 09-21	12.50%
Pertois-Lebrun - Blanc de Blancs Grand Cru L'Extravertie	s.a.	75€
100 Chardonnay - Extra Brut		
Côte des Blancs - Cramant	Sb: 03-21	12.00%
Pertois-Lebrun - Blanc de Blancs Grand Cru L'Extravertie	s.a.	150€
100 Chardonnay - Extra Brut		
Côte des Blancs - Cramant	Sb: 03-21	12.00%
	Magnum	
Pertois-Lebrun - Blanc de Blancs Grand Cru L'Egoïste	2012	110€
100 Chardonnay - Extra Brut		
Côte des Blancs - Cramant	Sb: 10-20	12.00%

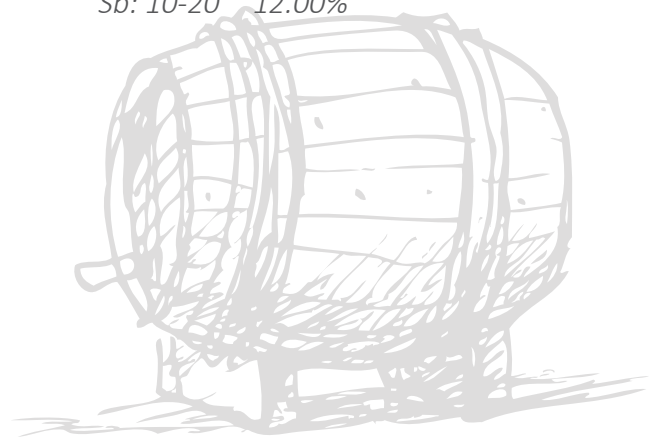

Spumanti Francesi

French sparkling wines

	R. Pouillon & Fils - Grande Vallée	<i>s.a</i>	75€
	<i>65 Pinot Noir, 20 Munier, 15 Chardonnay - Brut</i>		
	<i>Vallée de la Marne - Mareuil sur Aÿ</i>	<i>Sb: 07-21</i>	<i>12.00%</i>
	R. Pouillon & Fils - Brut Rosé de Saignée Premier Cru	<i>s.a</i>	85€
	<i>100 Pinot Noir</i>		
	<i>Vallée de la Marne - Mareuil sur Aÿ</i>	<i>Sb: 12-20</i>	<i>12.00%</i>
	Ruinart - Dom Ruinart Blanc de Blancs	2009	250€
	<i>100 Chardonnay - Brut</i>		
	<i>Reims</i>		<i>12.50%</i>



Vini Bianchi e Rosati Piemontesi

Piedmont White and Rosé Wines



AGRITURISMO LA MARGHERITA

06

ARNEIS

- | | | | |
|--|------|-----|--------|
| ● Cascina Fornace
<i>Vino bianco da uve arneis</i>
<i>Biologico non certificato</i>
Santo Stefano Roero (CN) | 2020 | 19€ | 12.50% |
| ● Cascina Fornace
<i>Roero Arneis</i>
<i>Biologico non certificato</i>
Santo Stefano Roero (CN) | 2017 | 26€ | 12.50% |
| ● Cascina Fornace
<i>Roero Arneis</i>
<i>Biologico non certificato</i>
Santo Stefano Roero (CN) | 2016 | 28€ | 13.00% |
| ● Costa Mario - Miladui
<i>Roero Arneis</i>
Canale (CN) | 2018 | 20€ | 14.50% |
| ● Alberto Oggero
<i>Roero bianco</i>
<i>Biologico non certificato</i>
Santo Stefano Roero - Canale (CN) | 2020 | 19€ | 12.50% |
| ● Pace
<i>Roero Arneis</i>
Canale (CN) | 2020 | 15€ | 14.00% |
| ● Pace - Giuan da Pas
<i>Roero Arneis</i>
Canale (CN) | 2011 | 40€ | 13.50% |
| ● Marco Porello
<i>Roero Arneis</i>
Veza d'Alba (CN) | 2020 | 14€ | 13.00% |
| ● Marco Porello - Camestri
<i>Roero Arneis</i>
Veza d'Alba (CN) | 2020 | 18€ | 13.50% |

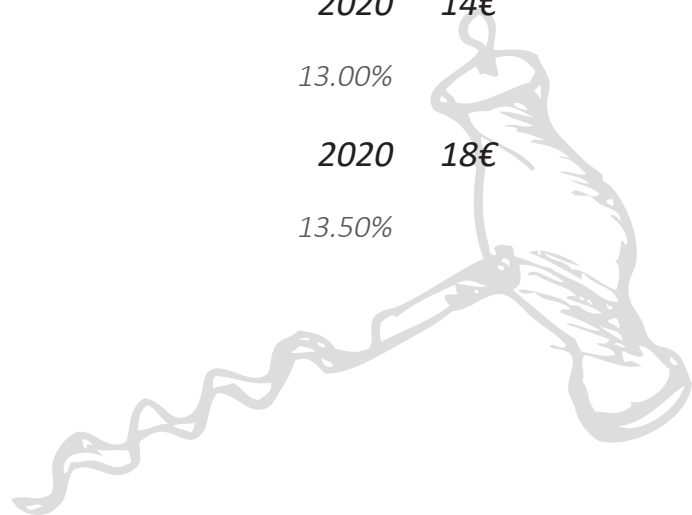

Vini bianchi e rosati piemontesi

Piedmont white and rosé wines

CHARDONNAY

- | | | | |
|---|------|-----|--------|
| ● Coppo - Moneriolo
<i>Piemonte Chardonnay</i>
Costigliole d'Asti (AT) | 2017 | 50€ | 13.00% |
| ● Coppo - Moneriolo
<i>Piemonte Chardonnay</i>
Costigliole d'Asti (AT) | 2008 | 75€ | 12.50% |
| ● Bruno Rocca - Cadet
<i>Langhe Chardonnay</i>
Barbaresco (CN) | 2019 | 25€ | 13.00% |

CORTESE

- | | | | |
|--|------|-----|--------|
| ● Albino Rocca - La Rocca
<i>Piemonte Cortese</i>
<i>Vitivinicoltura ecosostenibile</i>
Barbaresco e San Rocco Seno d'Elvio (CN) | 2017 | 28€ | 13.50% |
| ● Tenuta San Pietro - Gavi
<i>Gavi</i>
<i>Biologico Certificato</i>
Tassarolo (AL) | 2020 | 20€ | 12.50% |



ERBALUCE

- | | | | |
|---|------|-----|--------|
| ● Ciek
<i>Erbaluce di Caluso</i>
Giorgio Canavese (TO) | 2020 | 16€ | 13.00% |
| ● Ciek - T
<i>Erbaluce di Caluso</i>
Giorgio Canavese (TO) | 2018 | 20€ | 13.00% |

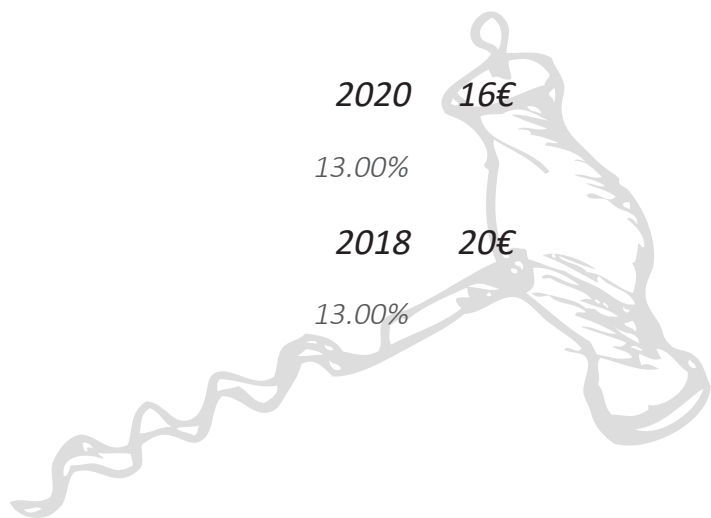

Vini bianchi e rosati piemontesi

Piedmont white and rosé wines

FAVORITA

- **Deltetto - Servaj** 2020 16€
Langhe Favorita 12.50%
Canale (CN)

NASCETTA

- **Mauro Marengo** 2020 22€
Langhe Nas-cetta 13.50%
Novello (CN)

TIMORASSO

- **Pomodolce - Diletto** 2019 25€
Colli Tortonesi Timorasso 14.00%
Biologico Certificato
Montermarzano (AL)
- **Vigneti Giacomo Boveri - Piccolo Derthona** 2020 20€
Piccolo Derthona 13.00%
Costa Vescovato (AL)
- **Vigneti Giacomo Boveri - Lacrime del Bricco** 2018 30€
Derthona 13.50%
Costa Vescovato (AL)



Vini Bianchi Rosati Italiani

Italian White and Rosé Wines



AGRITURISMO LA MARGHERITA

10

ALTO ADIGE

- **Putzenhof - Catasto n°1/I Riesling Tuatara** 2016 40€
Alto Adige Riesling

FRIULI VENEZIA GIULIA

- **Venica & Venica - Chardonnay Ronco Bernizza** 2019 26€
Collio Chardonnay
Dolegna del Collio (GO) 13.50%
- **Venica & Venica - Sauvignon Blanc Ronco del Cerò** 2020 29€
Collio Sauvignon Blanc
Dolegna del Collio (GO) 13.50%
- **Vie de Romans - Sauvignon Blanc Vieris** 2019 35€
Friuli Isonzo Sauvignon Blanc
Mariano (GO) 14.00%
- **Vie de Romans - Flors di Uis Cuvée** 2019 35€
Friuli Isonzo Bianco - 57 malvasia istriana, 8 friulano e 35 riesling renano
Mariano (GO) 13.50%

MARCHE

- **Collestepano - Verdicchio di Matelica** 2020 16€
Verdicchio di Matelica
Biologico Certificato
Castelraimondo (MC) 13.00%

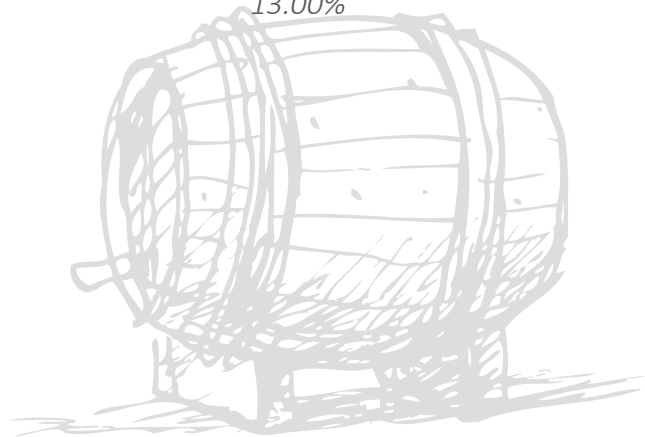

Vini bianchi e rosati italiani

Italian white and rosé wines

PUGLIA

- **Morella - Mezzarosa Rosato** 2020 19€
Salento - Negramaro, Primitivo
Manduria (TA) 13.00%

VALLE D'AOSTA

- **Les Crêtes - Chardonnay Cuvée Bois** 2018 55€
Vallée d'Aoste Chardonnay
Aymavilles (AO) 14.00%
- **Les Crêtes - Chardonnay Cuvée Bois** 2017 55€
Vallée d'Aoste Chardonnay
Aymavilles (AO) 14.50%
- **Ermes Pavese - Blanc de Morgex et de la salle Nathan** 2018 40€
Blanc de Morgex et de la salle
Morgex e di La Salle (AO) 14.50%



Vini Rossi Piemontesi

Piedmont Red Wines



AGRITURISMO LA MARGHERITA

13

BARBERA

● Marcarini - Ciabot Camerano <i>Barbera d'Alba</i> La Morra (CN)	2019	19€	13.50%
● Mario Costa - S-Ciass <i>Barbera d'Alba Superiore</i> Canale (CN)	2016	26€	14.50%
● Mario Costa - Mario Costa <i>Barbera d'Alba Superiore</i> Canale (CN)	2016	65€	15.50%
● Figli Luigi Oddero <i>Barbera d'Alba</i> La Morra (CN)	2018	20€	15.00%
● Paola Massa <i>Barbera d'Alba</i> Piobesi d'Alba (CN)	2020	20€	14.50%
● Palladino - Bricco delle Olive <i>Barbera d'Alba Superiore</i> Serralunga d'Alba (CN)	2019	30€	14.00%
● Pelissero - Piani <i>Barbera d'Alba</i> Treiso (CN)	2019	21€	14.00%
● Marco Porello <i>Barbera d'Alba</i> Canale (CN)	2020	15€	14.00%
● Vietti - Vigna Scarrone <i>Barbera d'Alba</i> Castiglione d'Alba (CN)	2016	45€	15.00%

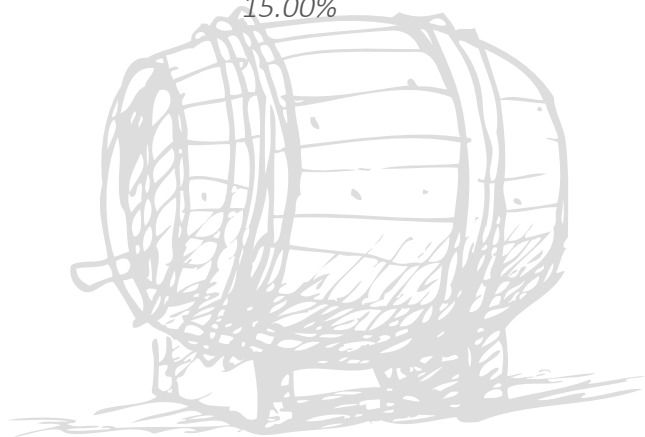

Vini rossi piemontesi

Piedmont red wines

● Coppo - L'Avvocata Barbera d'Asti Canelli (AT)	2020	17€	14.50%
● Coppo - Camp du Rouss Barbera d'Asti Canelli (AT)	2019	22€	14.00%
● Coppo - Camp du Rouss Barbera d'Asti Canelli (AT)	Magnum 2019	45€	14.00%
● Coppo - Pomorosso Nizza Canelli (AT)	2017	60€	16.00%
● Coppo - Pontiselli Nizza Canelli (AT)	2017	75€	16.00%
● Coppo - Nizza Riserva della Famiglia Nizza Riserva Canelli (AT)	2015	150€	15.50%
● Sette Barbera d'Asti Nizza Monferrato (AT)	2019	24€	14.50%
● Vigneti Boveri Giacomo - 19 Marzo 1878 Colli Tortonesi Barbera Costa Vescovato (AL)	2020	19€	14.50%

Ruché

● Montalbera - Laccento Ruché Castagnole Monferrato (AT)	2019	20€	15.00%
---	------	-----	--------

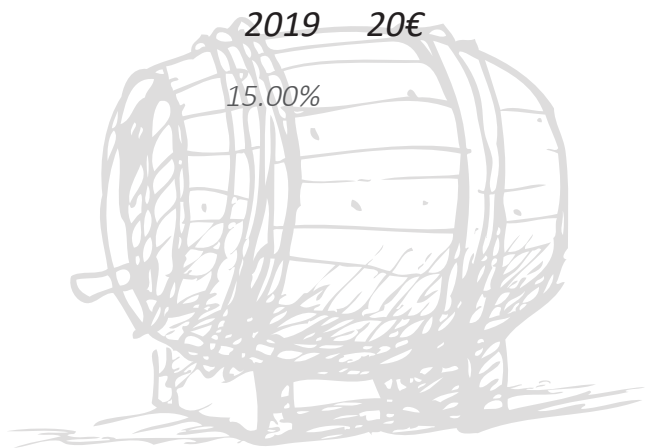

PINOT NERO

- | | | | |
|---|---|--------|-----|
|  | Deltetto - 777 | 2019 | 28€ |
| | Langhe Pinot Nero
Biologico Certificato
Canale (CN) | 13.50% | |
| | Saracco | 2019 | 30€ |
| | Piemonte Pinot Nero
Castiglione Tinella (CN) | 13.50% | |

DOLCETTO

- | | | | |
|--|-------------------------------------|--------|-----|
| | Marziano Abbona - Papà Celso | 2019 | 24€ |
| | Dogliani
Dogliani (CN) | 14.00% | |
| | Diavolorosso - Briccobracchi | 2020 | 18€ |
| | Dogliani
Dogliani (CN) | 13.00% | |
| | Bruno Rocca - Trifolè | 2020 | 18€ |
| | Dolcetto d'Alba
Barbaresco (CN) | 13.50% | |
| | Trediberri - Bricco Mollea | 2020 | 22€ |
| | Dogliani
Vicoforte (CN) | 13.00% | |



Vini rossi piemontesi

Piedmont red wines

GRIGNOLINO

● **Crotin 1897 - San Patelu**

Grignolino d'Asti

Biologico Certificato

Maretto (AT)

2020 19€

13.00%



NEBBIOLO

● **Ca' del Baio**

Langhe Nebbiolo

Treiso (CN)

2020 18€

14.00%

● **Hilberg - Pasquero**

Nebbiolo d'Alba Superiore

Lavorazione bioergodinamica

Priocca (CN)

2014 50€

14.50%

● **Mario Costa - Cianin da Stiva**

Nebbiolo d'Alba Superiore

Canele (CN)

2017 30€

14.50%

● **Massolino**

Langhe Nebbiolo

Serralunga d'Alba (CN)

2019 22€

14.00%

● **Fratelli Luigi Oddero**

Langhe Nebbiolo

La Morra (CN)

2018 24€

14.50%

● **Palladino**

Nebbiolo d'Alba

Serralunga d'Alba (CN)

2020 26€

14.00%

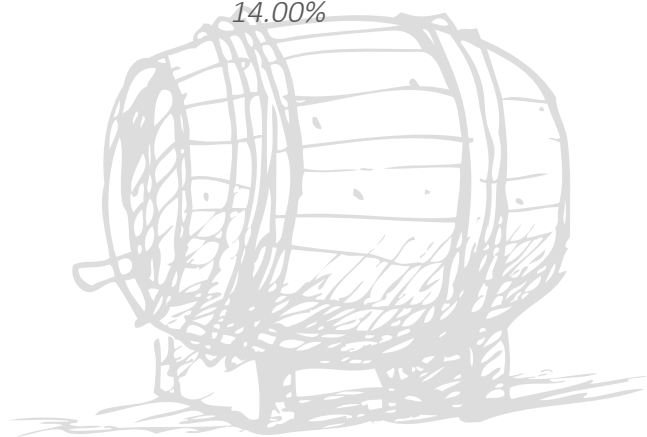

Vini rossi piemontesi

Piedmont red wines

- | | | | |
|---|--------------------|------|--------|
| ● Marco Porello
Langhe Nebbiolo
Veza d'Alba (CN) | 2020 | 17€ | 14.00% |
| ● Albino Rocca
Nebbiolo d'Alba
Barbaresco (CN) | 2020 | 25€ | 14.50% |
| ● Albino Rocca
Nebbiolo d'Alba
Barbaresco (CN) | Magnum 2020 | 50€ | 14.50% |
| ● Giovanni Rosso - Ester Canale
Langhe Nebbiolo
Serralunga d'Alba (CN) | 2016 | 150€ | 14.00% |

NORD PIEMONTE

- | | | | |
|--|------|-----|--------|
| ● Colombera & Garella - Coste della Sesia Cascina Cottignano
70 Nebbiolo, 15 Vespolina, 15 Croatina
Masserano e Roasio (BI) | 2020 | 25€ | 12.50% |
| ● Colombera & Garella - Bramaterra Cascina Cottignano
80 Nebbiolo, 10 Vespolina, 10 Croatina
Masserano (BI) | 2017 | 40€ | 13.00% |
| ● Colombera & Garella - Lessona Pizzaguerra
100 Nebbiolo
Lessona (BI) | 2018 | 45€ | 12.50% |
| ● Proprietà Sperino - Coste della Sesia Uvaggio
75 Nebbiolo, 20 Vespolina, 5 Croatina
Lessona (BI) | 2017 | 38€ | 13.00% |
| ● Proprietà Sperino - Lessona
100 Nebbiolo
Lessona (BI) | 2015 | 80€ | 13.50% |

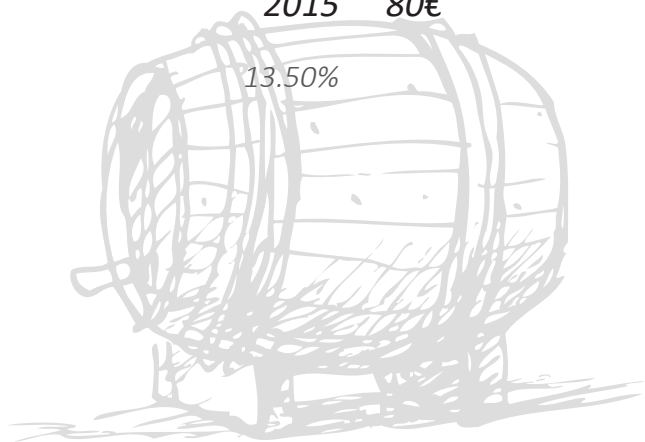

ROERO

- **Cascina Fornace - Sreja** 2014 55€
Roero da uve Nebbiolo
Biologico non certificato 13.50%
Santo Stefano Roero (CN)
- **Cascina Val del Prete - Bricco Medica** 2018 21€
Roero da uve Nebbiolo
Biologico Certificato 15.00%
Priocca (CN)
- **Deltetto - Gorrini** 2018 24€
Roero da uve Nebbiolo
Biologico Certificato 14.50%
Canale (CN)
- **Matteo Correggia** 2018 22€
Roero da uve Nebbiolo
Canale (CN) 14.00%
- **Matteo Correggia** **Magnum** 2018 45€
Roero da uve Nebbiolo
Canale (CN) 14.00%
- **Matteo Correggia - La Val dei Preti Riserva** 2018 35€
Roero da uve Nebbiolo
Canale (CN) 14.50%
- **Matteo Correggia - La Val dei Preti Riserva** **Magnum** 2017 80€
Roero da uve Nebbiolo
Canale (CN) 14.50%
- **Matteo Correggia - Ròche d'Ampsj** 2016 60€
Roero da uve Nebbiolo
Canale 14.50%



Vini rossi piemontesi

Piedmont red wines

- | | | | |
|---|--------------------|-----|--------|
| ● Mario Costa - Batistin
Roero da uve Nebbiolo
Canale (CN) | 2017 | 40€ | 14.50% |
| ● Mario Costa - Batistin
Roero da uve Nebbiolo
Canale (CN) | Magnum 2018 | 85€ | 14.50% |
| ● Alberto Oggero - Le Coste
Roero da uve Nebbiolo
<i>Biologico non certificato</i>
Santo Stefano Roero (CN) | 2019 | 28€ | 13.50% |
| ● Alberto Oggero - Le Coste
Roero da uve Nebbiolo
<i>Biologico non certificato</i>
Santo Stefano Roero (CN) | Magnum 2019 | 55€ | 13.50% |
| ● Alberto Oggero Riserva
Roero da uve Nebbiolo
<i>Biologico non certificato</i>
Santo Stefano Roero (CN) | 2016 | 48€ | 15.00% |
| ● Marco Porello - Torretta
Roero da uve Nebbiolo
Canale (CN) | 2019 | 23€ | 14.50% |



Vini rossi piemontesi

Piedmont red wines

Barbaresco di Barbaresco

	● Giuseppe Cortese - Rabaja Barbaresco da uve Nebbiolo Barbaresco	2018	60€	14.50%
	● Giuseppe Cortese - Rabaja Barbaresco da uve Nebbiolo Barbaresco	Magnum 2018	125€	14.50%
	● Giuseppe Cortese - Rabaja Barbaresco da uve Nebbiolo Barbaresco	2016	65€	14.50%
	● Moccagatta - Bric Balin Barbaresco da uve Nebbiolo Barbaresco	2013	50€	14.50%
	● Musso - Rio Sordo Barbaresco da uve Nebbiolo Barbaresco	2018	36€	14.50%
	● Musso - Pora Barbaresco da uve Nebbiolo Barbaresco	2016	38€	14.00%
	● Musso - Pora Barbaresco da uve Nebbiolo Barbaresco	2015	40€	14.00%
	● Musso - Rio Sordo Riserva Barbaresco Riserva da uve Nebbiolo Barbaresco	2013	50€	14.00%
	● Produttori del Barbaresco - Asili Riserva Barbaresco Riserva da uve Nebbiolo Barbaresco	2014	60€	14.00%
	● Produttori del Barbaresco - Montestefano Riserva Barbaresco Riserva da uve Nebbiolo Barbaresco	2014	60€	14.00%

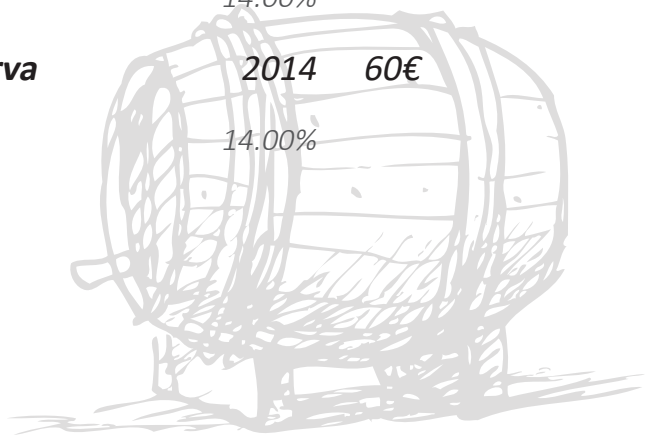

Vini rossi piemontesi

Piedmont red wines

	● Albino Rocca Barbaresco da uve Nebbiolo Barbaresco	2016	40€	14.00%
	● Albino Rocca Ovello Vigna Loreto Barbaresco da uve Nebbiolo Barbaresco	2016	60€	14.50%
	● Albino Rocca Ronchi Barbaresco da uve Nebbiolo Barbaresco	2015	55€	14.50%
	● Bruno Rocca Barbaresco da uve Nebbiolo Barbaresco	2015	55€	14.50%
	● Bruno Rocca Barbaresco da uve Nebbiolo Barbaresco	2014	55€	14.50%

Barbaresco di Neive

	● Fontanabianca - Serraboella Barbaresco da uve Nebbiolo Neive	2016	38€	14.50%
	● Fontanabianca - Bordini Barbaresco da uve Nebbiolo Neive	2016	50€	14.50%
	● Fontanabianca - Bordini Barbaresco da uve Nebbiolo Neive	2014	48€	14.00%
	● Francesco Versio Barbaresco da uve Nebbiolo Neive	2016	60€	
	● Francesco Versio Barbaresco da uve Nebbiolo Neive	2015	55€	14.50%

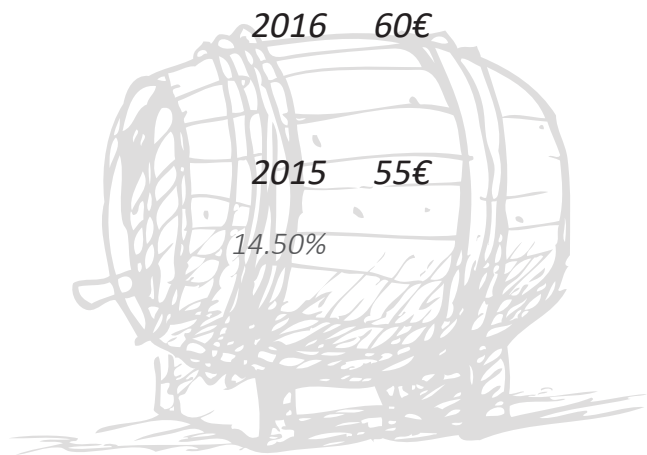

Vini rossi piemontesi

Piedmont red wines

Barbaresco di Treiso

- | | | | |
|--|------|-----|--------|
| ● Agricola Molino - Teorema
Barbaresco da uve Nebbiolo
Treiso | 2015 | 35€ | 14.50% |
| ● Agricola Molino - Ausario
Barbaresco da uve Nebbiolo
Treiso | 2015 | 45€ | 14.00% |
| ● Agricola Molino - Ausario
Barbaresco da uve Nebbiolo
Treiso | 2013 | 48€ | 14.00% |
| ● Giorgio Pelissero - Nubiola
Barbaresco da uve Nebbiolo
Treiso | 2015 | 37€ | 14.00% |
| ● Giorgio Pelissero - Nubiola
Barbaresco da uve Nebbiolo
Treiso | 2013 | 45€ | 14.00% |

Barolo di Castiglione Falletto

- | | | | |
|---|------|------|--------|
| ● Vietti - Castiglione
Barolo da uve Nebbiolo
Castiglione Falletto | 2015 | 55€ | 14.50% |
| ● Vietti - Castiglione
Barolo da uve Nebbiolo
Castiglione Falletto | 2014 | 55€ | 13.50% |
| ● Vietti - Castiglione
Barolo da uve Nebbiolo
Castiglione Falletto | 2013 | 60€ | 14.00% |
| ● Vietti - Rocche di Castiglione
Barolo da uve Nebbiolo
Castiglione Falletto | 2015 | 170€ | 14.00% |

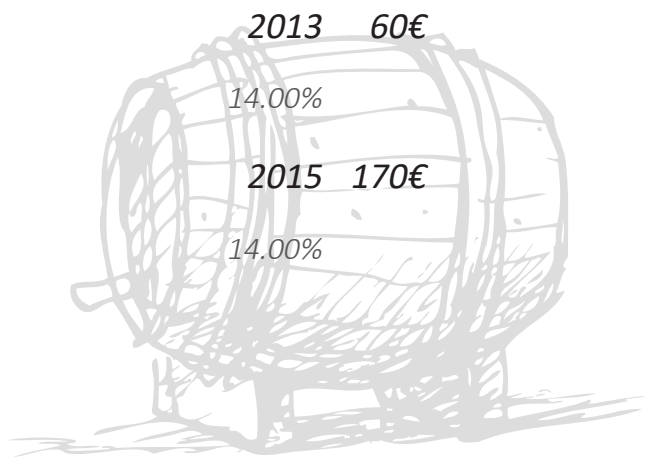

Vini rossi piemontesi

Piedmont red wines

Barolo di Barolo

- **Casa E. Mirafiore - Paigallo** 2013 80€
Barolo da uve Nebbiolo
Barolo 14.00%

Barolo di La Morra

- **Fratelli Revello** 2017 38€
Barolo da uve Nebbiolo
La Morra 15.00%
- **Marengo Mario** 2016 40€
Barolo da uve Nebbiolo
La Morra 14.50%
- **Marengo Mario** **Magnum** 2016 85€
Barolo da uve Nebbiolo
La Morra 14.50%
- **Marengo Mario - Bricco delle Viole** 2015 50€
Barolo da uve Nebbiolo
La Morra 14.50%
- **Marengo Mario - Brunate** 2016 60€
Barolo da uve Nebbiolo
La Morra 14.50%
- **Marengo Mario - Brunate** **Magnum** 2016 125€
Barolo da uve Nebbiolo
La Morra 14.50%
- **Marengo Mario - Brunate** 2015 60€
Barolo da uve Nebbiolo
La Morra 15.00%
- **Marengo Mario - Brunate Riserva** 2013 80€
Barolo da uve Nebbiolo
La Morra 14.00%

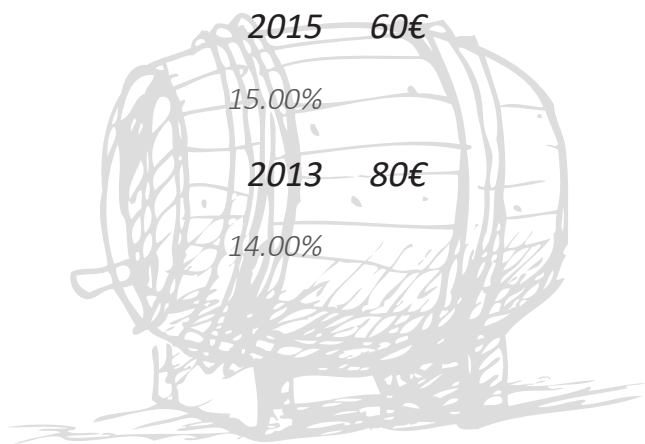

Vini rossi piemontesi

Piedmont red wines

Barolo di Monforte d'Alba

- | | | | |
|---|------|-----|--------|
| ● Marziano Abbona - Pressenda
<i>Barolo da uve Nebbiolo</i>
Monforte d'Alba | 2011 | 60€ | 15.00% |
| ● Aldo Conterno - Bussia
<i>Barolo da uve Nebbiolo</i>
Monforte d'Alba | 2015 | 90€ | 14.50% |
| ● Bussia Soprana - Mosconi
<i>Barolo da uve Nebbiolo</i>
Monforte d'Alba | 2006 | 80€ | 14.00% |
| ● Bussia Soprana - Mosconi
<i>Barolo da uve Nebbiolo</i>
Monforte d'Alba | 1997 | 95€ | 14.00% |
| ● Paolo Monti - Bussia Riserva
<i>Barolo Riserva da uve Nebbiolo</i>
Monforte d'Alba | 2010 | 90€ | 14.50% |
| ● Paolo Monti - Monforte d'Alba
<i>Barolo da uve Nebbiolo</i>
Monforte d'Alba | 2011 | 55€ | 15.50% |
| ● Parusso - 44° Annata
<i>Barolo da uve Nebbiolo</i>
Monforte d'Alba | 2014 | 50€ | 13.50% |

Barolo di Novello

- | | | | |
|---|------|-----|--------|
| ● Marziano Abbona - Ravera
<i>Barolo da uve Nebbiolo</i>
Monforte d'Alba | 2011 | 60€ | 15.00% |
|---|------|-----|--------|

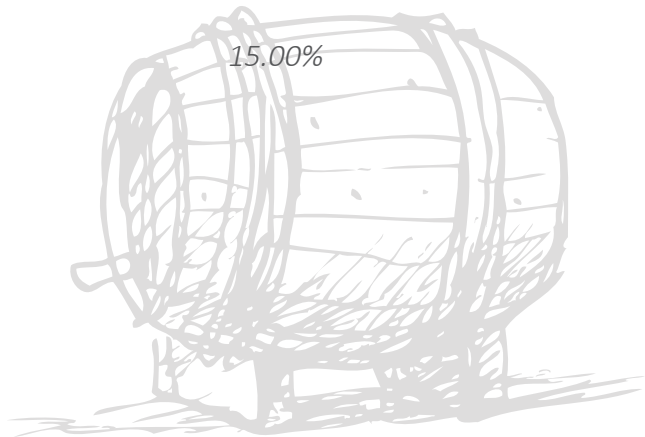

Vini rossi piemontesi

Piedmont red wines

Barolo di Serralunga d'Alba

- | | | | |
|--|------|------|--------|
| ● Ettore Germano - Prapò
<i>Barolo da uve Nebbiolo</i>
<i>Serralunga d'Alba</i> | 2013 | 65€ | 14.00% |
| ● Massolino
<i>Barolo da uve Nebbiolo</i>
<i>Serralunga d'Alba</i> | 2015 | 45€ | 14.00% |
| ● Massolino - Margheria
<i>Barolo da uve Nebbiolo</i>
<i>Serralunga d'Alba</i> | 2015 | 70€ | 14.50% |
| ● Massolino - Vigna Rionda
<i>Barolo da uve Nebbiolo</i>
<i>Serralunga d'Alba</i> | 2013 | 140€ | 14.00% |
| ● Palladino
<i>Barolo Riserva da uve Nebbiolo</i>
<i>Serralunga d'Alba</i> | 2017 | 50€ | 15.00% |
| ● Palladino - Ornato
<i>Barolo Riserva da uve Nebbiolo</i>
<i>Serralunga d'Alba</i> | 2013 | 65€ | 14.50% |
| ● Palladino - San Bernardo
<i>Barolo Riserva da uve Nebbiolo</i>
<i>Serralunga d'Alba</i> | 2012 | 80€ | 14.50% |
| ● Giovanni Rosso - Cerretta
<i>Barolo da uve Nebbiolo</i>
<i>Serralunga d'Alba</i> | 2015 | 85€ | 14.00% |
| ● Giovanni Rosso - Cerretta
<i>Barolo da uve Nebbiolo</i>
<i>Serralunga d'Alba</i> | 2014 | 85€ | 14.00% |
| ● Giovanni Rosso - La Serra
<i>Barolo da uve Nebbiolo</i>
<i>Serralunga d'Alba</i> | 2014 | 85€ | 14.00% |
| ● Vietti - Lazzarito
<i>Barolo da uve Nebbiolo</i>
<i>Serralunga d'Alba</i> | 2014 | 170€ | 13.50% |

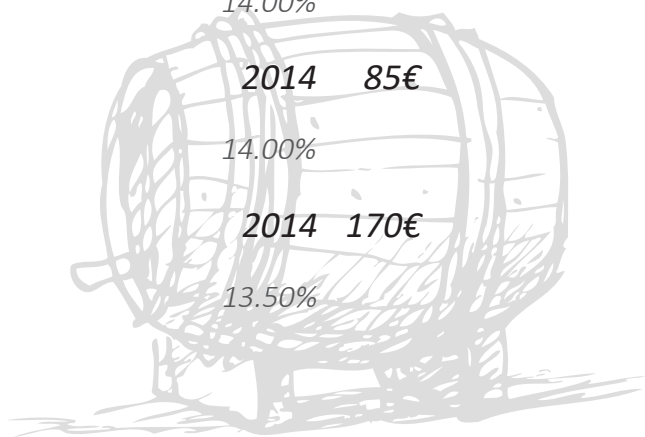

Vini rossi italiani

Italian Red Wines



AGRITURISMO LA MARGHERITA

28

Vini rossi italiani

Italian red wines

Alto Adige

- **Hofstätter - Pinot Nero Meczan** 2020 22€
Alto Adige Pinot Nero
Termeno (BZ) 13.00%
- **Hofstätter - Pinot Nero Riserva Mazon** 2018 40€
Alto Adige Pinot Nero
Termeno (BZ) 13.50%
- **Kollerhof - Pinot Nero Mazon** 2018 40€
Alto Adige Pinot Nero
Egna (BZ) 14.00%

Emilia Romagna

- **Chiara Condello - Sangiovese** 2019 30€
Romagna Sangiovese Predappio
Biologico Certificato 14.00%
Passopisciaro



Sicilia

- **Calcagno - Etna Rosso Nireddu** 2017 30€
Nerello Mascalese
Passopisciaro 14.00%



Vini rossi italiani

Italian red wines

Toscana

- **Le Macchiole - Bolgheri Rosso** 2019 30€
Merlot, Cabernet Franc, Cabernet Sauvignon, Syrah
Castagneto Carducci (LI) 14.50%
- **Tenuta San Guido - Le Difese** 2020 38€
Cabernet Sauvignon, Sangiovese
Castagneto Carducci (LI) 14.00%

Valle d'Aosta

- **Ottin - Fumin** 2018 35€
Valle d'Aosta dop da uve Pinot Nero
Aosta 13.50%
- **Ottin - Pinot Noir** 2019 30€
Valle d'Aosta dop da uve Pinot Nero
Aosta 13.50%
- **La Plantze - Torrette Superieur** 2019 26€
Valle d'Aosta doc da uve Petit Rouge, Cornalin, Fumin
Villeneuve 14.00%



Vini dolci

Sweet wines



AGRITURISMO LA MARGHERITA

31

Vini dolci

Sweet wines

Italia

Piemonte

- | | | | |
|--|--------------------|-----|--------|
| ● Ciek - Passito di Caluso Alladium 375ml
<i>Erbaluce di Caluso</i>
<i>Giorgio Canavese</i> | 2013 | 35€ | 14.50% |
| ● Correggia Matteo - Passito Anthos 375ml
<i>Brachetto</i>
<i>Canale</i> | s.a. | 25€ | 11.00% |
| ● Fabio Perrone - Moscato d'Asti
<i>Moscato Bianco</i>
<i>Santo Stefano Belbo</i> | Magnum 2019 | 35€ | 5.50% |
| ● Fabio Perrone - Passito Spuri 500 ml.
<i>Moscato Bianco</i>
<i>Santo Stefano Belbo</i> | 2016 | 30€ | 13.50% |
| ● Saracco - Moscato d'Asti
<i>Moscato Bianco</i>
<i>Castiglione Tinella</i> | 2021 | 20€ | 5.50% |
| ● Sette - Moscato d'Asti
<i>Moscato Bianco</i>
<i>Nizza Monferrato</i> | 2018 | 17€ | 5.50% |

Valle d'Aosta

- | | | | |
|--|------|-----|--------|
| ● Ermes Pavese - Vino da uve stramature Ninive
<i>Prié Blanc</i>
<i>Morgex e di La Salle (AO)</i> | s.a. | 50€ | 14.00% |
|--|------|-----|--------|

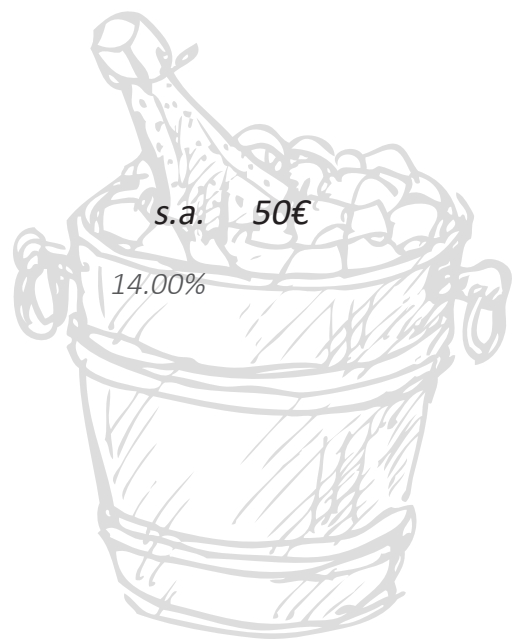

Francia

- **Chateaux Gravas - Sauternes 375ml.**
Sauternes
Gironde, Bordeaux

2016 24€

13.00%

